

## Surface Mount Super Fast Recovery Rectifier



### Features

- Low profile package
- Ideal for automated placement
- Glass passivated chip junction
- High forward surge capability
- Super Fast reverse recovery time
- Meets MSL level 1, per J-STD-020, LF maximum peak of 260 °C

### Typical Applications

For use in high frequency rectification of power supplies, inverters, converters, and freewheeling diodes for consumer, and telecommunication.

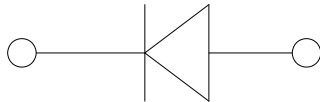

### Mechanical Data

- **Package:** DO-214AA (SMB)  
Molding compound meets UL 94 V-0 flammability rating, -compliant, halogen-free
- **Terminals:** Tin plated leads, solderable per J-STD-002 and JESD22-B102
- **Polarity:** Cathode line denotes the cathode end

### ■ Maximum Ratings (Ta=25°C Unless otherwise specified)

PARAMETER	SYMBOL	UNIT	MURS120B	MURS140B	MURS160B
Device marking code			MURS120B	MURS140B	MURS160B
Maximum Repetitive Peak Reverse Voltage	VRRM	V	200	400	600
Maximum RMS Voltage	VRMS	V	140	280	420
Maximum DC blocking Voltage	VDC	V	200	400	600
Average rectified output current @60Hz sine wave, resistance load, TL (Fig.1)	IO	A	1.0		
Forward Surge Current (Non-repetitive) @60Hz Half-sine wave, 1 cycle, Tj=25°C	IFSM	A	30		
Forward Surge Current (Non-repetitive) @1ms, square wave, 1 cycle, Tj=25°C			60		
Current squared time @1ms≤t≤8.3ms Tj=25°C	I²t	A²s	3.735		
Storage temperature	Tstg	°C	-55 ~ +150		
Junction temperature	Tj	°C	-55 ~ +150		

# MURS120B THRU MURS160B

## ■Electrical Characteristics (T<sub>a</sub>=25°C Unless otherwise specified)

PARAMETER	SYMBOL	UNIT	TEST CONDITIONS	MURS120B	MURS140B	MURS160B
Maximum instantaneous forward voltage	V <sub>F</sub>	V	I <sub>FM</sub> =1.0A	0.92	1.25	
Maximum reverse recovery time	t <sub>rr</sub>	ns	I <sub>F</sub> =0.5A, I <sub>R</sub> =1.0A, I <sub>rr</sub> =0.25A	25	50	
Maximum DC reverse current at rated DC blocking voltage	I <sub>R</sub>	μA	T <sub>j</sub> =25°C	5.0		
			T <sub>j</sub> =125°C	50		
Typical junction capacitance	C <sub>j</sub>	pF	Measured at 1MHz and Applied Reverse Voltage of 4.0 V.D.C	17	15	14

## ■Dynamic Characteristics

### ◆ MURS120B

PARAMETER	SYMBOL	UNIT	TEST CONDITIONS		Min	Typ	Max
Reverse Recovery Time	T <sub>RR</sub>	ns	T <sub>j</sub> =25°C	I <sub>F</sub> =1A, di/dt=-50A/us V <sub>RM</sub> =30V	-	26	-
			T <sub>j</sub> =25°C	I <sub>F</sub> =1A di/dt=-200A/us V <sub>RM</sub> =100V	-	18	-
			T <sub>j</sub> =125°C		-	23	-
Peak recovery current	I <sub>RRM</sub>	A	T <sub>j</sub> =25°C	I <sub>F</sub> =1A di/dt=-200A/us V <sub>RM</sub> =100V	-	2.3	-
			T <sub>j</sub> =125°C		-	3.8	-
Reverse recovery charge	Q <sub>rr</sub>	nC	T <sub>j</sub> =25°C	I <sub>F</sub> =1A di/dt=-200A/us V <sub>RM</sub> =100V	-	20.2	-
			T <sub>j</sub> =125°C		-	43.7	-
Non-repetitive avalanche energy	E <sub>AS</sub>	mJ	T <sub>j</sub> =25°C	I <sub>R</sub> =1.5 A, L=15 mH	16.9	-	-

### ◆ MURS140B

PARAMETER	SYMBOL	UNIT	TEST CONDITIONS		Min	Typ	Max
Reverse Recovery Time	T <sub>RR</sub>	ns	T <sub>j</sub> =25°C	I <sub>F</sub> =1A, di/dt=-50A/us V <sub>RM</sub> =30V	-	26	-
			T <sub>j</sub> =25°C	I <sub>F</sub> =1A di/dt=-200A/us V <sub>RM</sub> =200V	-	22	-
			T <sub>j</sub> =125°C		-	31	-
Peak recovery current	I <sub>RRM</sub>	A	T <sub>j</sub> =25°C	I <sub>F</sub> =1A di/dt=-200A/us V <sub>RM</sub> =200V	-	1.9	-
			T <sub>j</sub> =125°C		-	3.5	-
Reverse recovery charge	Q <sub>rr</sub>	nC	T <sub>j</sub> =25°C	I <sub>F</sub> =1A di/dt=-200A/us V <sub>RM</sub> =200V	-	21.1	-
			T <sub>j</sub> =125°C		-	54.9	-
Non-repetitive avalanche energy	E <sub>AS</sub>	mJ	T <sub>j</sub> =25°C	I <sub>R</sub> =0.4A, L=15 mH	1.2	-	-

### ◆ MURS160B

PARAMETER	SYMBOL	UNIT	TEST CONDITIONS		Min	Typ	Max
Reverse Recovery Time	T <sub>RR</sub>	ns	T <sub>j</sub> =25°C	I <sub>F</sub> =1A, di/dt=-50A/us V <sub>RM</sub> =30V	-	49	-
			T <sub>j</sub> =25°C	I <sub>F</sub> =1A di/dt=-200A/us V <sub>RM</sub> =400V	-	38	-
			T <sub>j</sub> =125°C		-	59	-
Peak recovery current	I <sub>RRM</sub>	A	T <sub>j</sub> =25°C	I <sub>F</sub> =1A di/dt=-200A/us V <sub>RM</sub> =400V	-	3.5	-
			T <sub>j</sub> =125°C		-	5.5	-
Reverse recovery charge	Q <sub>rr</sub>	nC	T <sub>j</sub> =25°C	I <sub>F</sub> =1A di/dt=-200A/us V <sub>RM</sub> =400V	-	67.4	-
			T <sub>j</sub> =125°C		-	160.5	-
Non-repetitive avalanche energy	E <sub>AS</sub>	mJ	T <sub>j</sub> =25°C	I <sub>R</sub> =0.5A, L=15 mH	1.9	-	-

# MURS120B THRU MURS160B

## ■ Thermal Characteristics (T<sub>a</sub>=25°C Unless otherwise specified)

PARAMETER	SYMBOL	UNIT	MURS120B	MURS140B	MURS160B
Typical Thermal resistance	R $\theta$ J-A <sup>(1)</sup>	°C/W	65		
	R $\theta$ J-L <sup>(1)</sup>		20		
	R $\theta$ J-C <sup>(1)</sup>		18		

Note:  
 (1) Thermal resistance from junction to ambient and from junction to lead mounted on P.C.B. with 0.3" x 0.3" (8.0 mm x 8.0 mm) copper pad areas

## ■ Characteristics (Typical)

FIG.1: I<sub>o</sub>-T<sub>L</sub> Curve

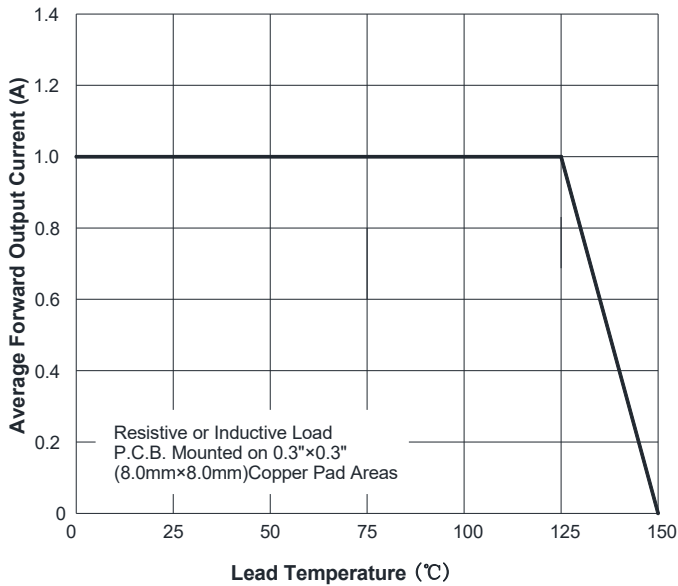

FIG.2: Forward Surge Current Capacity

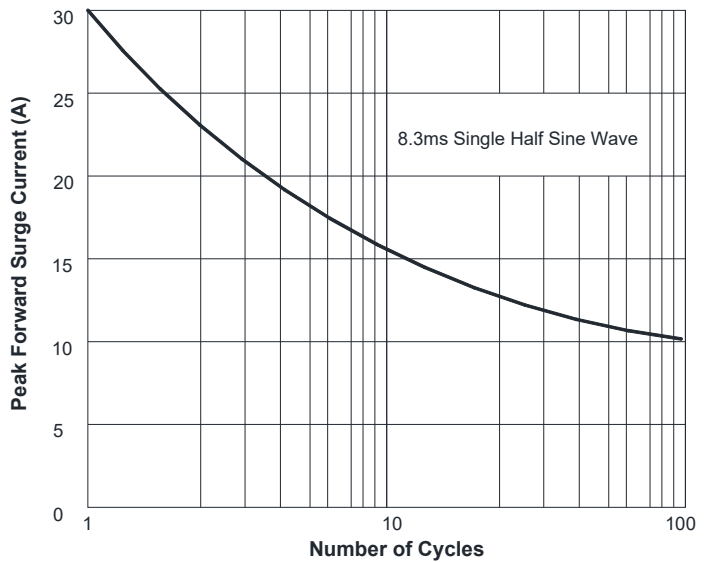

FIG.3: Typical Forward Voltage

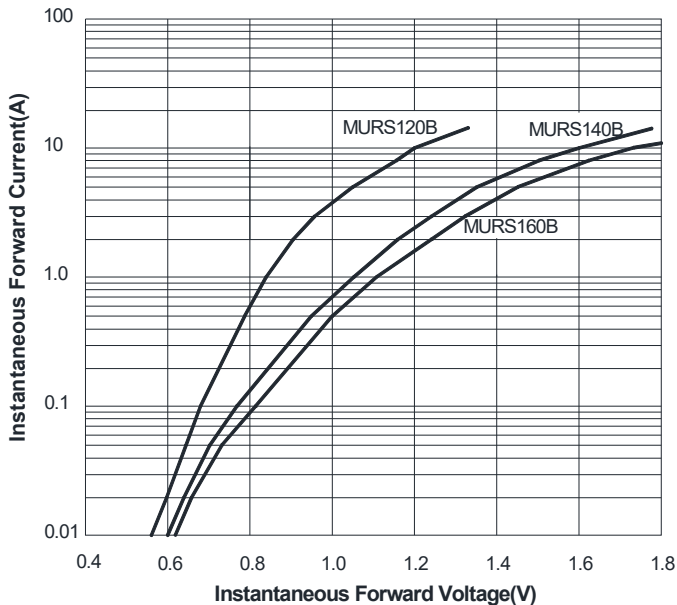
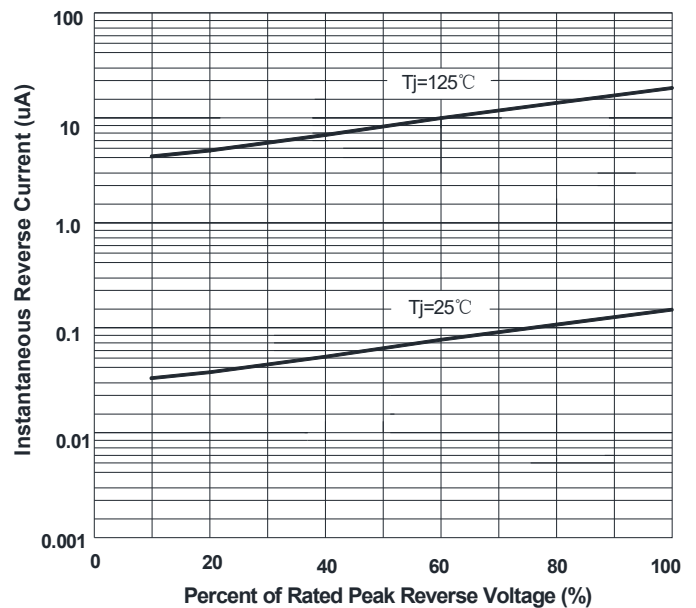
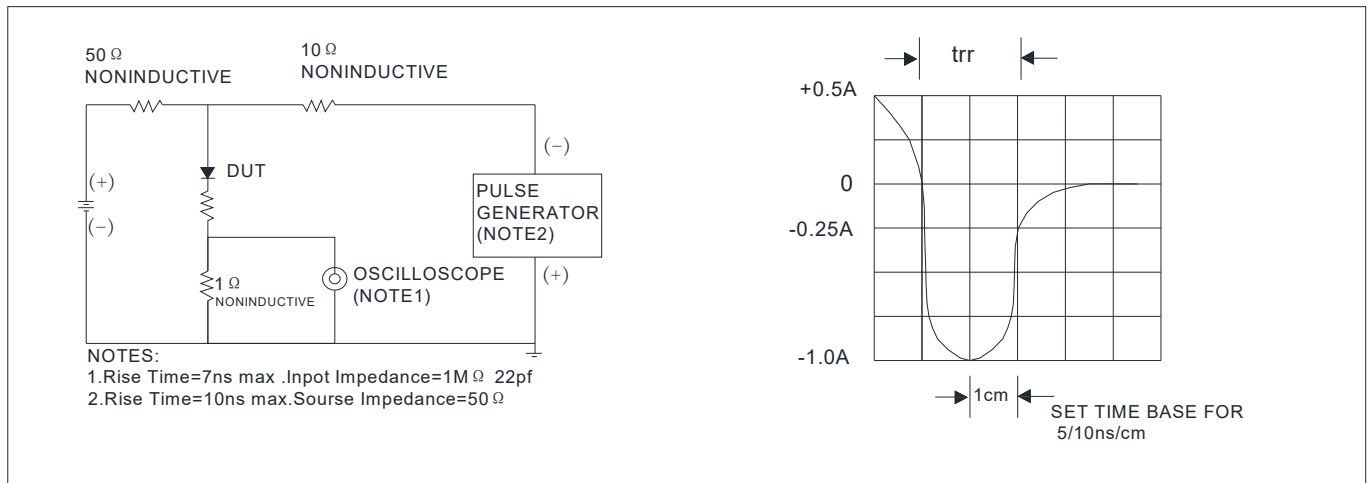

FIG.4: Typical Reverse Characteristics



# MURS120B THRU MURS160B

FIG.5: Diagram of circuit and Testing wave form of reverse recovery time



## Ordering Information (Example)

PREFERRED P/N	PACKING CODE	UNIT WEIGHT(g)	MINIMUM PACKAGE(pcs)	INNER BOX QUANTITY(pcs)	OUTER CARTON QUANTITY(pcs)	DELIVERY MODE
MURS120B-MURS160B	F1	Approximate 0.096	3000	/	48000	13" reel
MURS120B-MURS160B	F2	Approximate 0.096	750	6000	24000	7" reel
MURS120B-MURS160B	F3	Approximate 0.096	500	4000	16000	7" reel

## Outline Dimensions

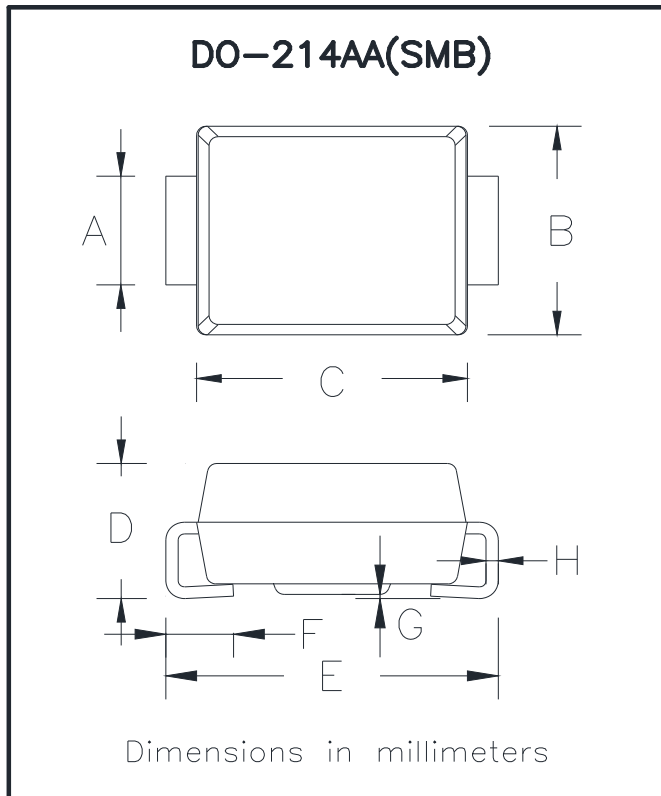

DO-214AA(SMB)		
Dim	Min	Max
A	1.85	2.15
B	3.30	3.94
C	4.05	4.75
D	1.99	2.61
E	5.21	5.59
F	0.90	1.41
G	0.05	0.20
H	0.15	0.31

■ Suggested pad layout

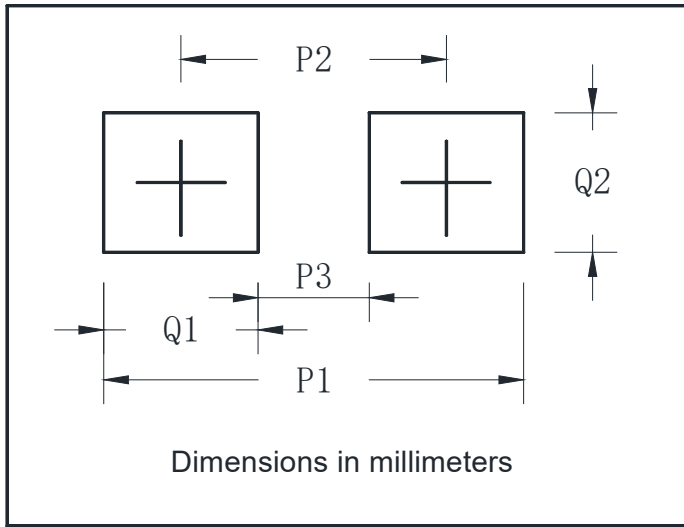

DO-214AA(SMB)	
Dim	Millimeters
P1	6.8
P2	4.3
P3	1.8
Q1	2.5
Q2	2.3

**Disclaimer**

The information presented in this document is for reference only. Shanghai Sunco Electronics Co., Ltd reserves the right to make changes without notice for the specification of the products displayed herein to improve reliability, function or design or otherwise.

The product listed herein is designed to be used with ordinary electronic equipment or devices, and not designed to be used with equipment or devices which require high level of reliability and the malfunction of which would directly endanger human life (such as medical instruments, transportation equipment, aerospace machinery, nuclear-reactor controllers, fuel controllers and other safety devices), Russiansunco or anyone on its behalf, assumes no responsibility or liability for any damages resulting from such improper use of sale.

This publication supersedes & replaces all information previously supplied. For additional information, please visit our website [http:// www.russiansunco.com](http://www.russiansunco.com) , or consult your nearest Russiansunco's sales office for further assistance.